

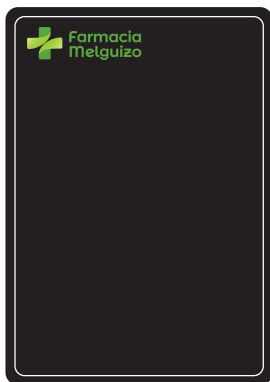

- 3 unid. A6V
(10,5 x 14,85 cm.)



- 9 unid. A7H
(10,5 x 7,4 cm.)



- 6 unid. A6H
(14,85 x 10,5 cm.)

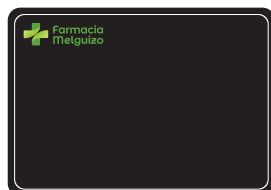

- 3 unid. A6V
(10,5 x 14,85 cm.)



- 9 unid. A7H
(10,5 x 7,4 cm.)



- 6 unid. A6H
(14,85 x 10,5 cm.)



- 3 Unid. Pinzas

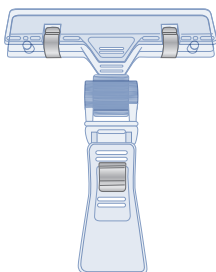

- Rotulador tiza líquida



- 12 Unid. Bases

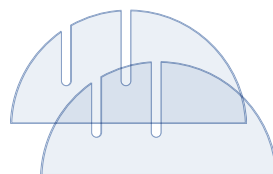

- 3 Unid. Pinzas

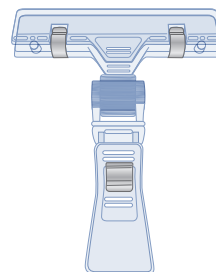

- Rotulador tiza líquida



- 12 Unid. Bases

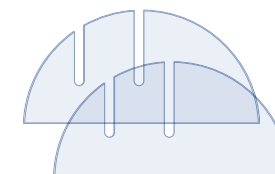



1º Coloque la pestaña trasera de la pizarra dentro del lineal.

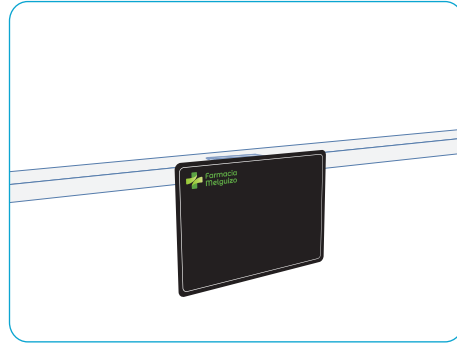
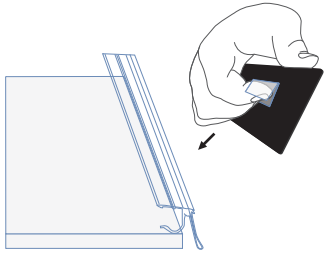

1º Coloque la pizarra en la sobre las medias lunas.

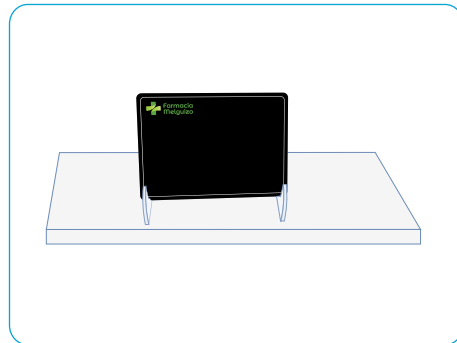
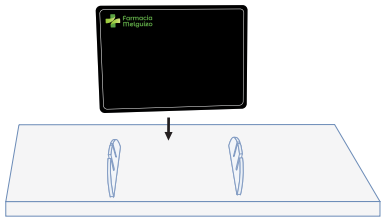

1º Coloque la pinza en la balda y en la otra pestaña la pizarra.

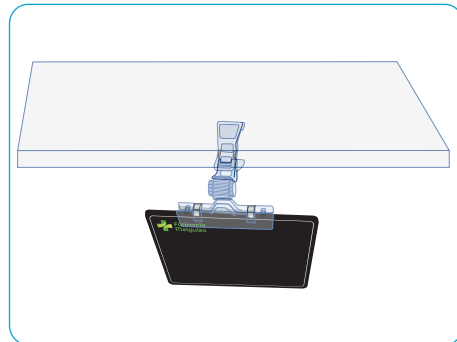
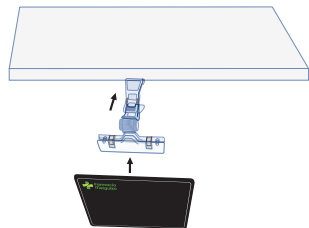

1º Coloque la pestaña trasera de la pizarra dentro del lineal.

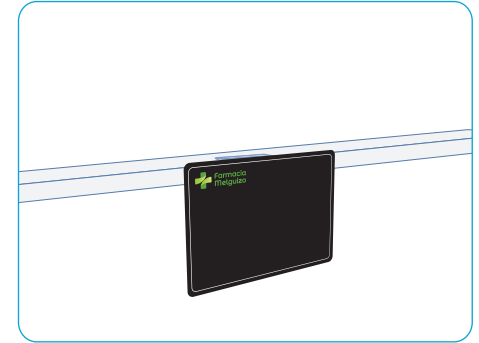
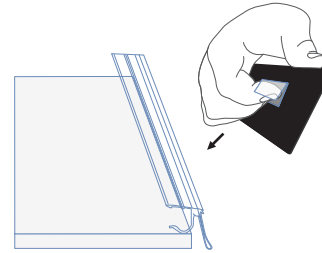

1º Coloque la pizarra en la sobre las medias lunas.

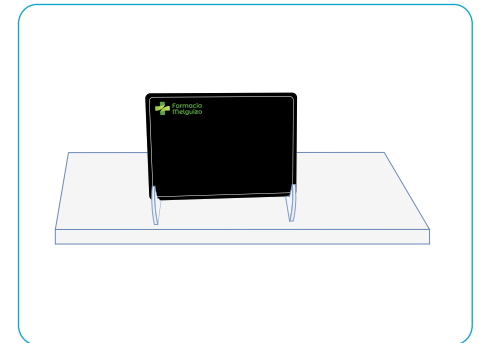
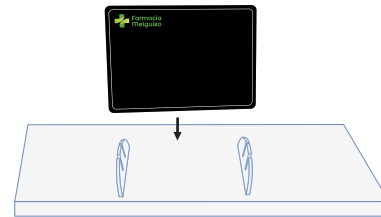

1º Coloque la pinza en la balda y en la otra pestaña la pizarra.

